

Varenummer: 203180M1675C4V

Beskrivelse: E+G Justerfod

GN 31-80-M16-75-C4-V

Note: V Uden møtrik, udvendig sekskant i toppen, spændeflade i bunden

## Mål

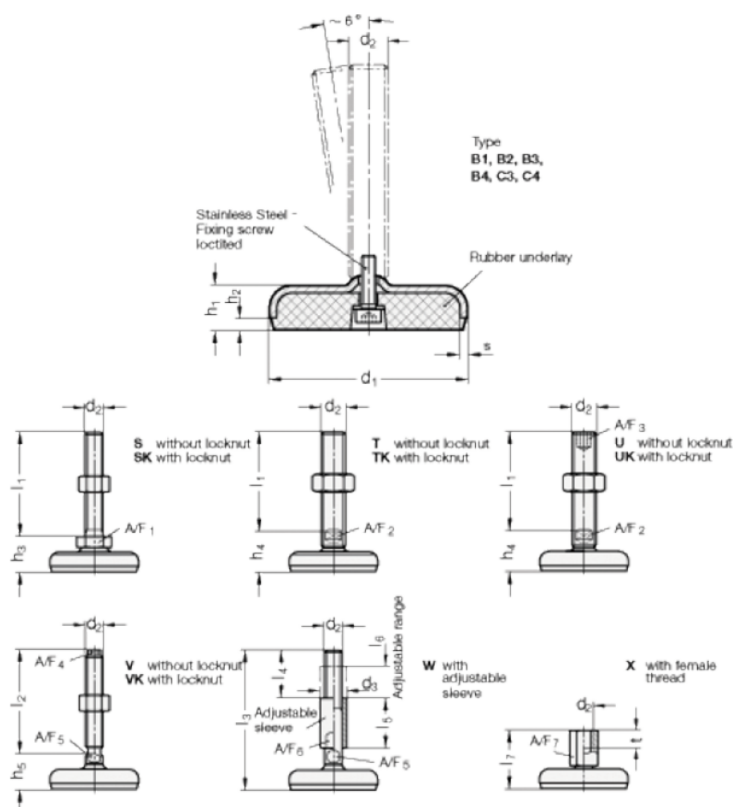

A/F4	= 10	s = 3
A/F5	= 12	
d1	= 80	
d2	= 16	
h1	= 18	
h5 +4.0/0	= 29	
l2	= 75	